

# Szolmet Kft.



**HARDOX®**  
IN MY BODY

# FT

ROTATING PULVERIZER



szolmet.hu



## ROTATING PULVERIZER

FRANTUMATORE GIREVOLE

BROYEUR ROTATIF

DREHBARE PULVERISIERER







GARRA PULVERIZADORA

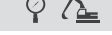

**HARDOX**  
IN MY BODY

**Szalmét**  
Manufacturing  
Solutions  
Partner

**PG**

MODEL		FT140	FT190	FT250
A	mm	2026	2315	2680
B	mm	688	795	917
C	mm	748	880	996
D	mm	438	458	488
E	mm	290	305	334
	mm	200	200	200
F1	t	182	235	303
F2	t	108	134	149
F3	t	64	71	86
Rotation flow	l/min	20/30	20/30	20/30
 max	bar	120	120	120
 max	l/min	140/200	180/230	250/300
 max	bar	350	350	350
 max	°	360	360	360
	kg	1540	1995	2610
	t	15/22	18/25	24/30

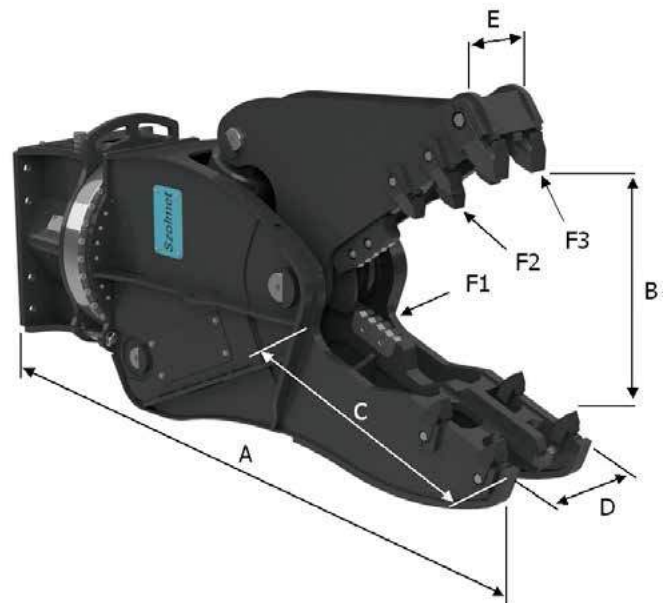

Specifications are subject to change without notice.

SZOLMET KFT  
H-5004 Szolnok, Mártírok út 53  
Levelezési cím: H-5004 Szolnok, Pf.:21. Telefon 56/520-160 - Fax: 56/520-169